

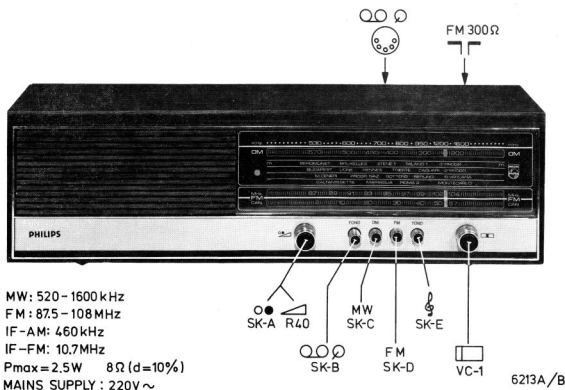





Service Service Service

- (GB) New version, using print nr. ET774/2
- (NL) Nieuwe versie, voorzien van print nr. ET774/2
- (F) Nouvelle version avec platine no ET774/2
- (D) Neue Ausführung, ausgestattet mit Print ET774/2
- (I) Nuova versione con piastra stampata no ET774/2

Service Manual



Wave range	Signal to		Var. cap.	Adjust	Indication
SK-C/D					
SK-C	1	A	Min. cap.	XR-3a,b	1 max.
MW: (520-1605 kHz)	520 kHz	A	Max. cap.	S5	1 max.
	1600 kHz		Tune in	C63	
	550 kHz		Tune in	S7	
	1400 kHz		Tune in	C60	
SK-D	2	A	Min. cap.	S1 S2	1 max.
FM: (87.5-108 MHz)	86,5 MHz	B	Max. cap.	S10	1 max.
	109 MHz		Min. cap.	C62	
	89 MHz		Tune-in	S8	
	104 MHz		Tune-in	C61	

↓ Repeat-Herhalen-Répéter-Wiederholen-Ripetere-

(GB)

- Supply an AM-modulated signal (approx. 460 kHz $\Delta f = 1000$ Hz)
Adjust the frequency of the signal generator so that the output voltage at 1 is maximum. This is now the resonance frequency of XR-3 and therefore also the frequency of the AM-IF signal supplied.
- Supply an FM-modulated signal (approx. 10,7 MHz $\Delta f = 1000$ Hz)
Adjust the frequency of the signal generator so that the output voltage at 1 is maximum. This is now the resonance frequency of XR-1, XR-2 and therefore also the frequency of the FM-IF signal supplied.

(F)

- Appliquer un signal AM modulé (± 460 kHz $\Delta f = 1000$ Hz).
Déterminer la fréquence du générateur HF à laquelle la tension de sortie sur 1 est au maximum. Il s'agit alors de la fréquence de résonance de XR-3 et donc de la fréquence du signal AM-FI appliqué.
- Appliquer un signal FM modulé ($\pm 10,7$ MHz $\Delta f = 1000$ Hz)
Déterminer la fréquence du générateur HF à laquelle la tension de sortie sur 1 est au maximum. Il s'agit aussi de la fréquence de résonance de XR-1, XR-2 et de ce fait de la fréquence du signal FM-F.I. appliqué.

(I)

- Applicare un segnale AM modulato (± 460 kHz $\Delta f = 1000$ Hz).
Determinare la frequenza del generatore AF alla quale la tensione di uscita su di 1 è al massimo. Si tratta quindi della frequenza di risonanza di XR-3 e nello stesso tempo della frequenza del segnale AM-F.I. applicato.

(NL)

- Voer een A.M. - gemoduleerd signaal toe (± 460 kHz $\Delta f = 1000$ Hz)
Bepaal de frequentie van de signaal-generator waarbij de uitgangsspanning op 1 maximaal is. Dit is nu de resonantiefrequentie van XR-3 en dus ook de frequentie van het toegevoerde AM-MF-signaal
- Voer een F.M. gemoduleerd signaal toe ($\pm 10,7$ MHz $\Delta f = 1000$ Hz)
Bepaal de frequentie van de signaal generator vanaf de uitgangsspanning op 1 max. is.
Dit is nu de resonantiefrequentie van XR-1, XR-2 en dus ook frequentie van het toegevoerde FM-MF-signaal.

(D)

- Ein amplitudenmoduliertes Signal (ca. 460 kHz $\Delta f = 1000$ Hz) zuführen.
Die Frequenz des Signalgenerators bestimmen, bei der die Ausgangsspannung an 1 maximal ist. Diese Frequenz ist die Resonanzfrequenz von XR-3 und also auch die Frequenz des AM-ZF-Signals.
- Ein FM-moduliertes Signal (ca. 10,7 MHz, $\Delta f = 1000$ Hz) zuführen.
Die Frequenz des Signalgenerators bestimmen, bei der die Ausgangsspannung an 1 maximal ist. Diese Frequenz ist die Resonanzfrequenz von XR-1, XR-2 und also auch die Frequenz der zugeführten FM-ZF-Signals.

- Applicare un segnale FM modulato ($\pm 10,7$ MHz $\Delta f = 1000$ Hz).
Determinare la frequenza del generatore AF alla quale la tensione di uscita su di 1 è al massimo. Si tratta anche della frequenza di risonanza di XR-1, XR-2 e quindi della frequenza del segnale FM - F.I. applicato.

C	41	42	VC1d	31	60	2	4	5	61	VC1a,7	11	8	9	13	12	62	16	VC1b	14	15	19	18	20a	50	20	21				
C	66							68	65				23	25	26	63	64	VC1c	67	28	27	30	31	53	6	32				
R	1			2	3			5	14					7	12	8	9			10	13	11				26				
R													16							18	15	19	20	21	24	22	2	3	6	25
MISC.	S6		S7	TS1				S8					S9	TS4	S10	D2		S1	D1	XR-1	XR-2					IC-1				
MISC.									TS2					S5	XR-3					TS3			D3	D4						

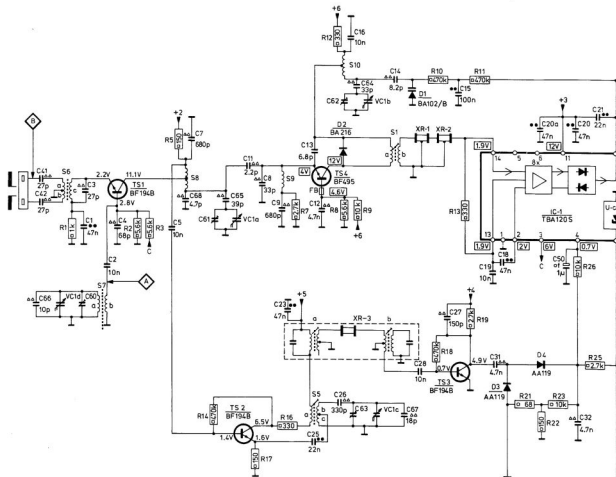

THE CIRCUIT IS DRAWN IN POSITION : MW
LE CIRCUIT EST DESSINÉ EN POSITION : PO

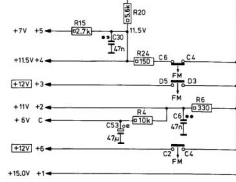
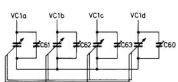

15	19	18	20a	50	20	21	22												
67	28	27	30	31	53	6	32	33	34	54	36	35	55	37	51	38	39	52	40
10	13	11	20	21	24	22	2	3	6	25	31	41	32	27	40	28	30	29	
D1	XR-1	XR-2	T53	D3	D4	IC-1	S2	41	32					27	40	28	30	29	
														D5	LA1	S11	VL-1	S3	M1

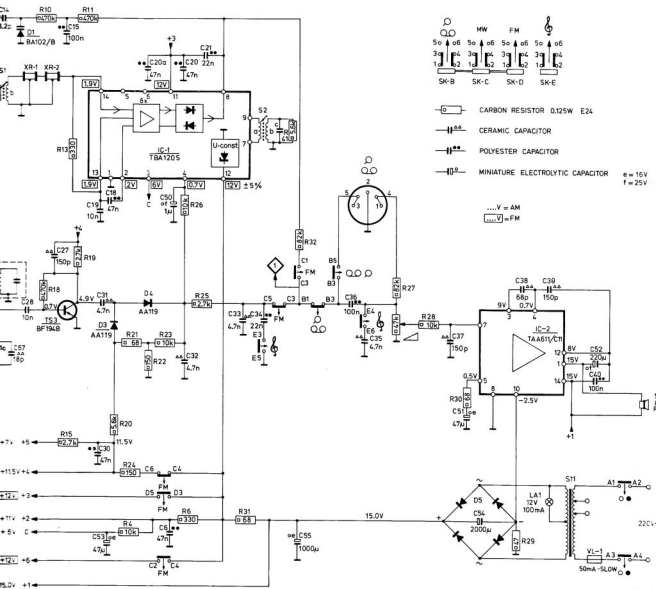

3. SK-B, D3	TS3	D5	IC-2			
3. 23. 31. 27...28. 36		54	51 37 55 38	52	39	40
23. 27. 18. 22. 21. 31			29 30 28			

TS 3
 e=0V
 b=0.7V
 c=4.9V

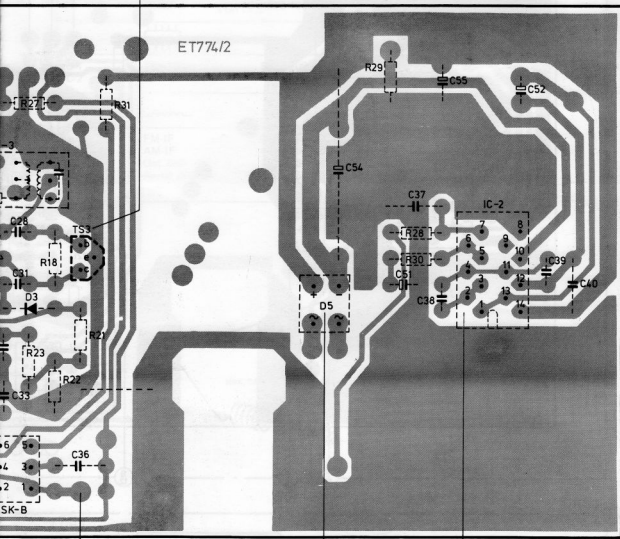

D 5
 +-+15V
 ---2.5V

IC-2
 1=15V
 3=9V
 4=0.7V
 5=0.5V
 8=0V
 10=-2.5V
 14=15V

6443D/C

1

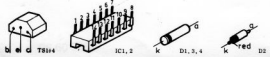

MISC	TS4_D2	D1	XR-1	VC-1	TS1	XR-2	SK-E	IC-1	TS2	SK-D	SK-C	D4	XF
S	9 1 10				8 6				5 2				
C	13 12,8...11 16			14,1,26,64...68,35,3,7,6,19	4 18	15,5,2,53,25,50,21,20,20			3,2 14...17,26,24,41,20,19,25			23,34,30,3	
R	9 12 7,8			10 1		13,6,5,4		11,3,2					

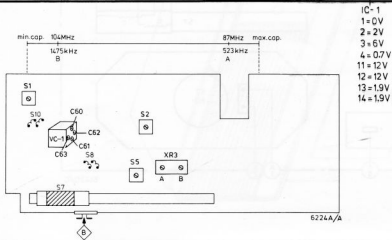
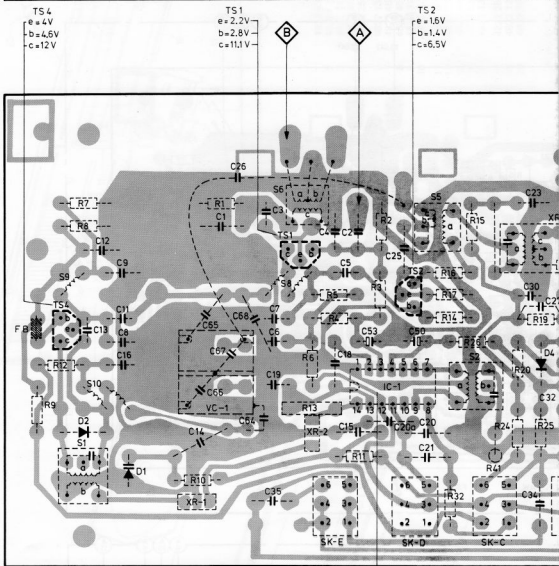

- IC-1
- 1=0V
 - 2=2V
 - 3=6V
 - 4=0,7V
 - 11=12V
 - 12=12V
 - 13=1,9V
 - 14=1,9V

MISC	S1	IC-2	LA1	D5	VL1	TS3	XR-3	D3,4	SK-B	SK-C	TS2		
S										2	5		
C	40	39	52	38	55	37	51	54	36	27,28,31-34	23,30	21,2	
R			28	30	29				40	31	21,22,18,27,23	25,19,20,24,41,26,16	17,14

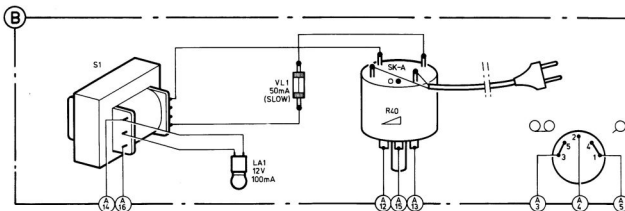
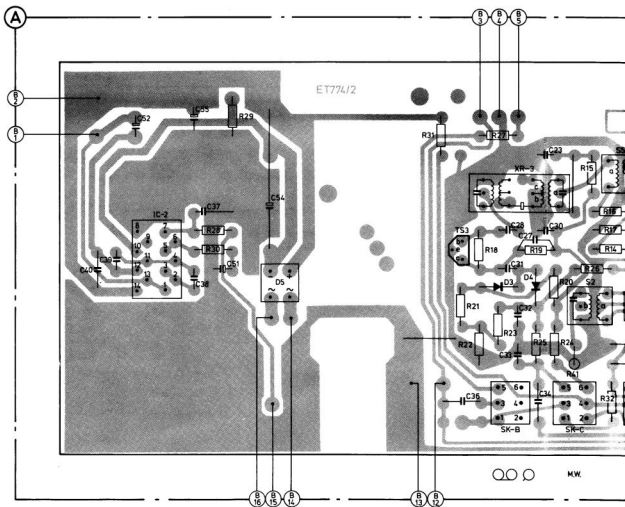



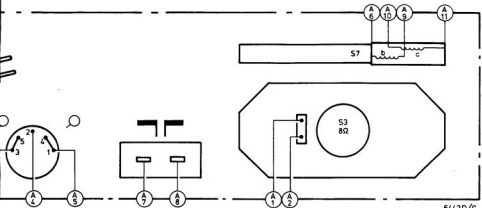
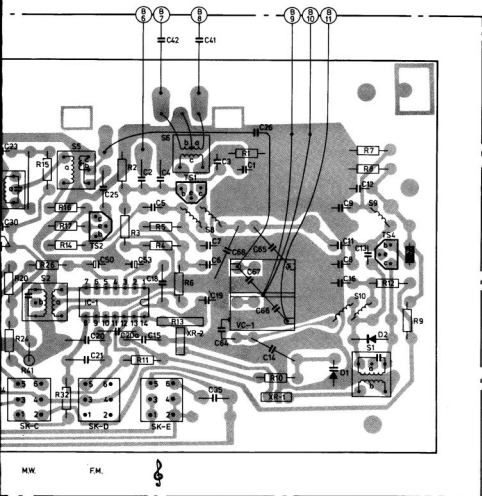

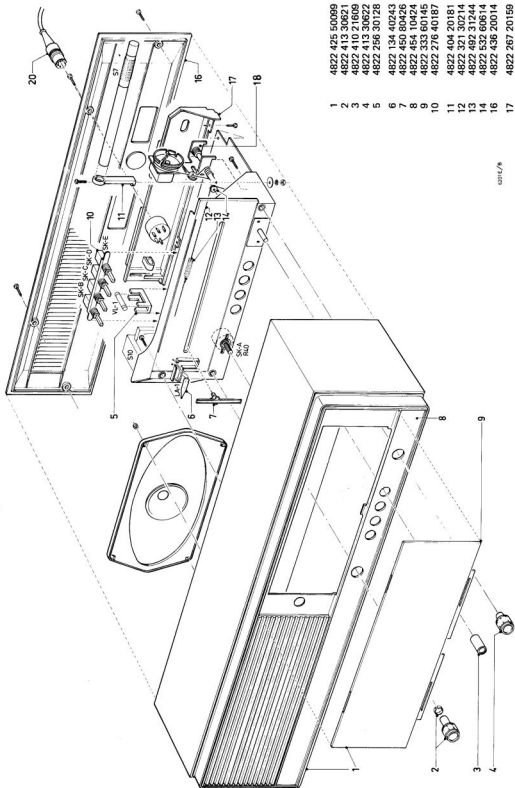
SK-C	TS2	SK-D	IC-1	SK-E	XR-2	TS1	XR-1	VC-1	D1	D2	TS4
2	5			6	8					3,7,10	9
23,30	21,20,50,25,20a,53,15,2,5,4,18,4,2			41,19,35,3,7,6	1,26	64	68	14		16,8,9,11,13,12	
0,24,41,26	16	17	14	32	2	3,11	5	4	6	13	1
											10
											7
											8
											12
											9





- 1 4822 425 50099
- 2 4822 413 30621
- 3 4822 410 21609
- 4 4822 413 30622
- 5 4822 256 30128
- 6 4822 134 40243
- 7 4822 450 80426
- 8 4822 454 10424
- 9 4822 353 60145
- 10 4822 276 40187
- 11 4822 404 20181
- 12 4822 321 30214
- 13 4822 492 31244
- 14 4822 532 60614
- 16 4822 436 20014
- 17 4822 267 20159
- 18 4822 125 20206
- 20 4822 264 40023

0391E/8

-TS-			-C-		
TS1,2,3 TS4	BF194B BF495	5322 130 40303 4822 130 40947	C2,5,16,19,28 C54	Cer. cap. 10 nF Eico 2000 μ F - 25 V	4822 122 30043 4822 124 20621
-D-			-Miscellaneous-		
D1 D2 D3,4 D5	BA102/B BA216 2-AA119 Rectifier	4822 130 30903 5322 130 30702 4822 130 30312 4822 130 50309	XR-1,2 VC-1 a,d S11 S7 a,b S3 R40 VL-1 LA-1	Cer. resonator (10,7 MHz) pair Varco assy Mainstransformer Ferroceptor-assy Loudspeaker 8 Ω Vol. control 47 k Ω Fuse 50 mA (slow) Lamp 12 V - 100 mA	4822 242 70247 4822 125 20206 4822 145 30146 4822 158 60415 4822 240 20116 4822 101 50181 4822 253 30003 4822 134 40243
-IC-					
IC-1 IC-2	TBA120/s TAA611/C-11	5322 209 84511 4822 209 80291			
-S-					
S1,2 XR-3 a,b S5 S6	FM-IF AM-IF Osc. coil Aerial adaptor	4822 153 60099 4822 156 30622 4822 156 40626 4822 158 10385			

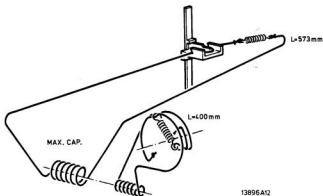

(GB)

Safety regulations require that the set be restored to its original condition and that parts which are identical with those specified, be used.

(F)

Les normes de sécurité exigent que l'appareil soit remis à l'état d'origine et que soient utilisées les pièces de rechange identiques à celles spécifiées.

(NL)

Veiligheidsbepalingen vereisen, dat het apparaat bij reparatie in zijn oorspronkelijke toestand wordt teruggebracht en dat onderdelen, identiek aan de gespecificeerde, worden toegepast.

(D)

Die Sicherheitsvorschriften erfordern, dass das Gerät sich nach der Reparatur in seinem originalen Zustand befindet und dass die benutzten Einzelteile den aufgeführten Teilen identisch sind.

(I)

Le norme di sicurezza esigono che l'apparecchio venga rimesso nelle condizioni originali e che siano utilizzati i pezzi di ricambio identici a quelli specificati.